

## INSTALLATION MANUAL TOYOTA CANOPY-ABS

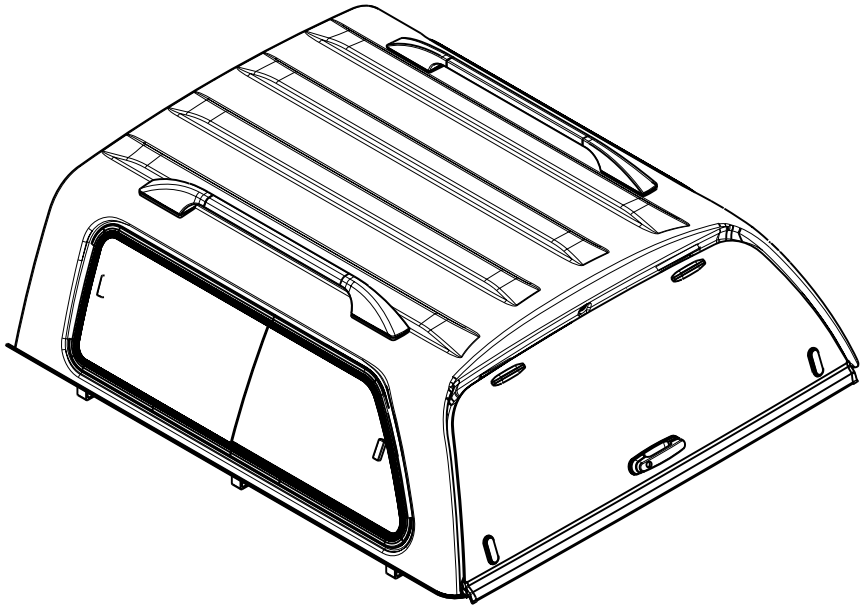

### **4X4 ACCESSORIES & TYRES LIMITED**

Meridian Park, Leeming Bar, North Yorkshire, D17 9UJ, United King dom  
Tel: +44 1677 42 55 55 Fax: +44 1677 42 56 66 E-mail: [mark@4x4at.com](mailto:mark@4x4at.com)

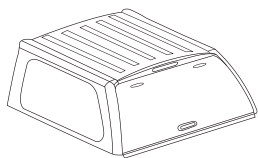
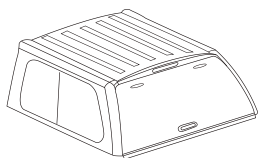
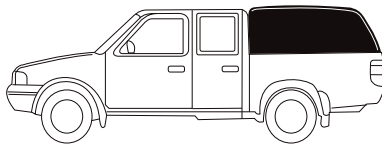
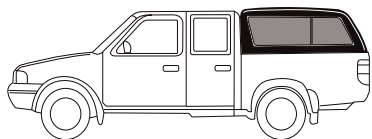

**OPTION #1**

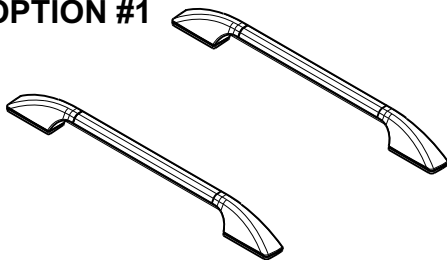

**X1**

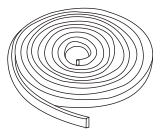

**X1**



**X1**



**X6**



**X6**



**X1**

**AEROKLAS**

**X2**



**X2**

50 mm.



No.10

No.5

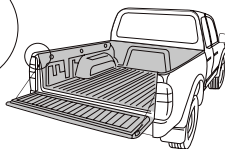

1 → 14

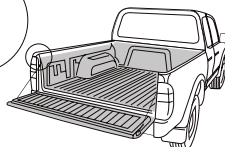

1 → 14



Silicone

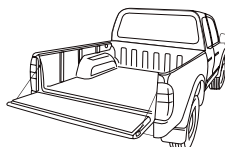
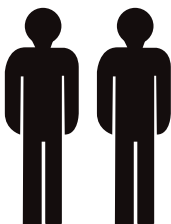
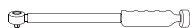

1 → 14

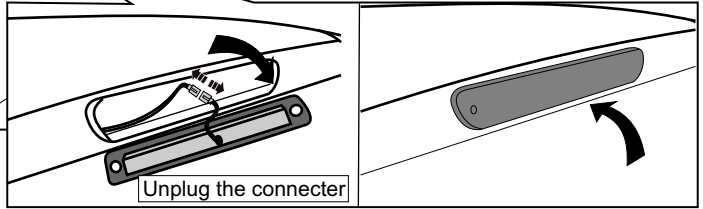
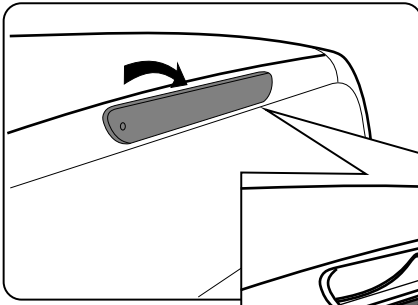

## TYPE # A

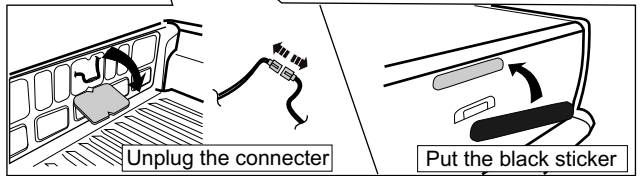
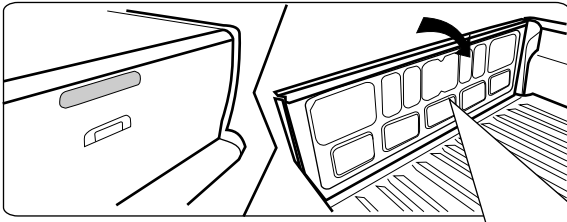

## TYPE # B

Put the black sticker

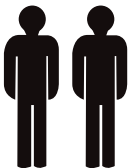
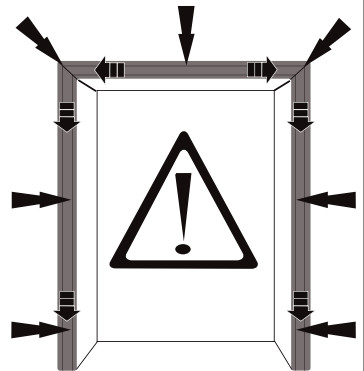
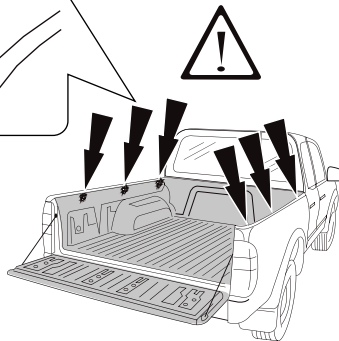
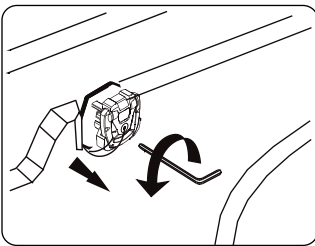

3

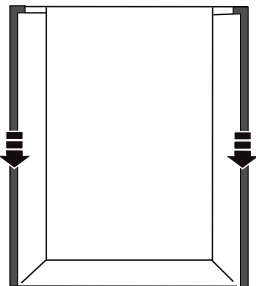
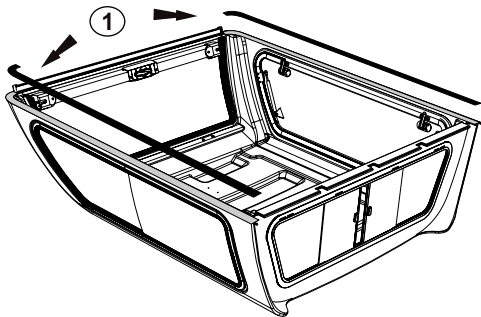
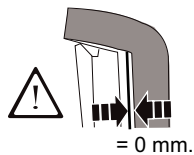
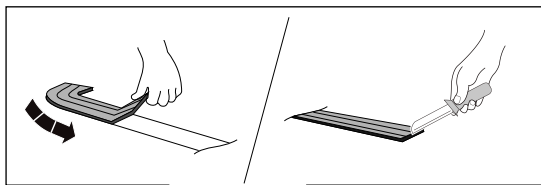

4

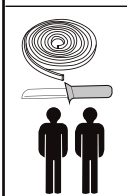
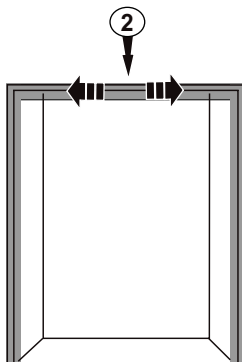
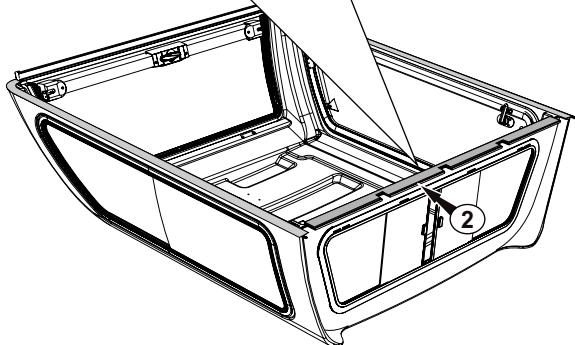
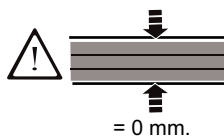
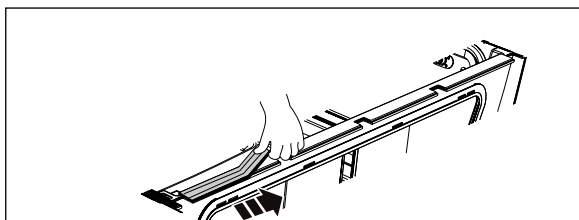

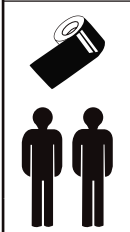
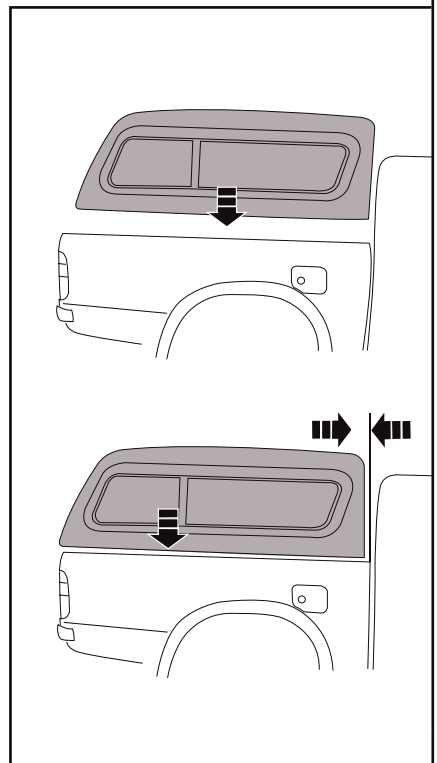
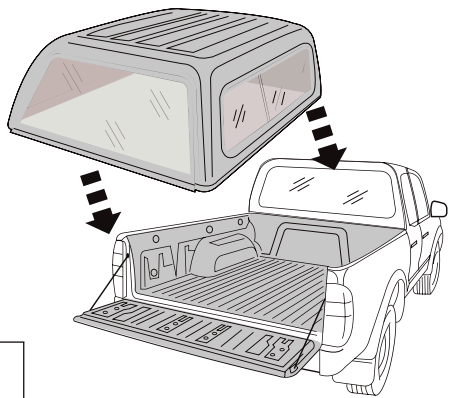
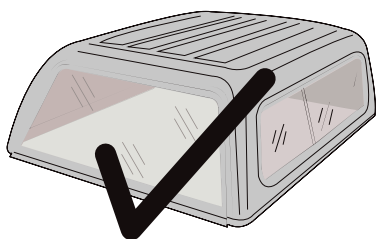
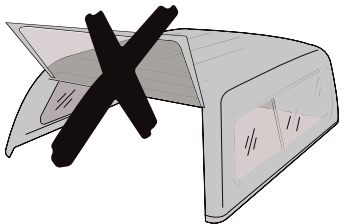
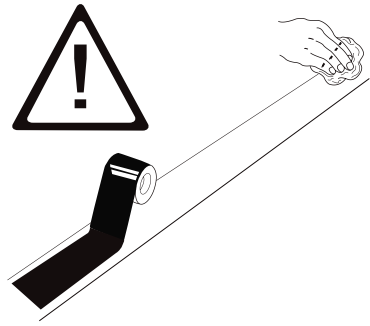
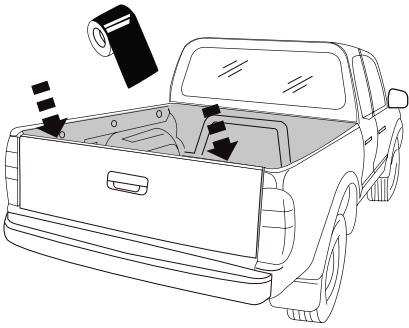

6

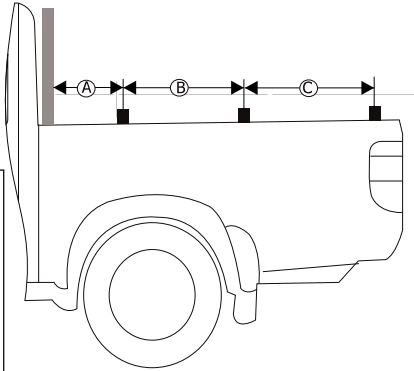
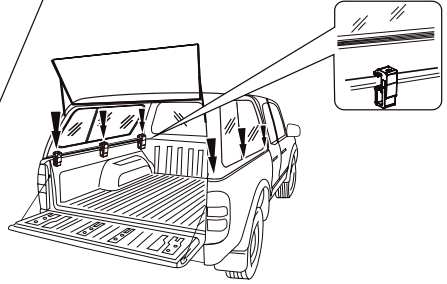
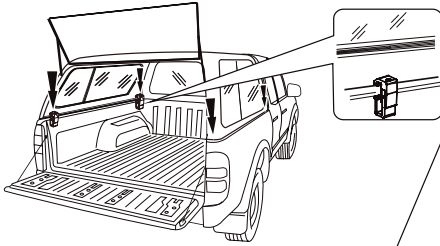
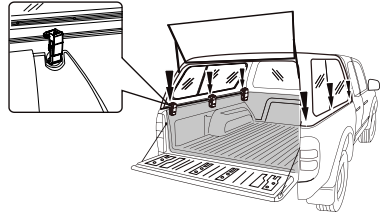
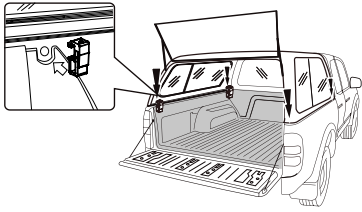

**C-CLAMP FITTING**

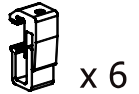

CAR MODEL	A	B	C
TOYOTA SP/C	200	700	700
TOYOTA D/C	250	500	500

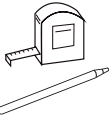

7

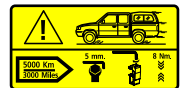
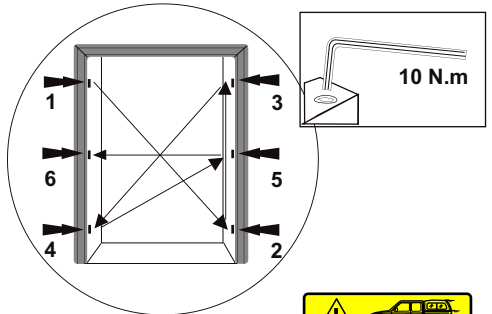
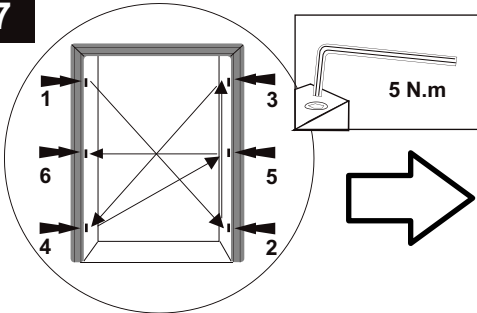

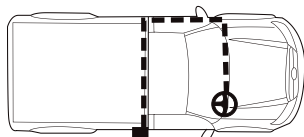
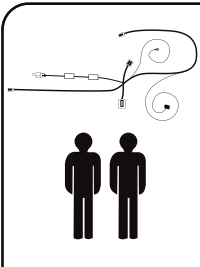

FOR: TOYOTA

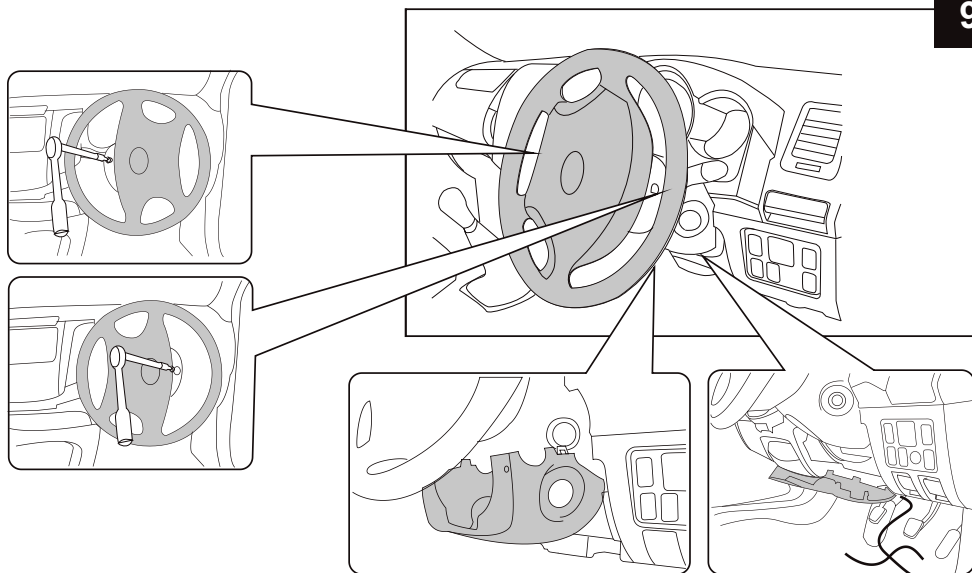
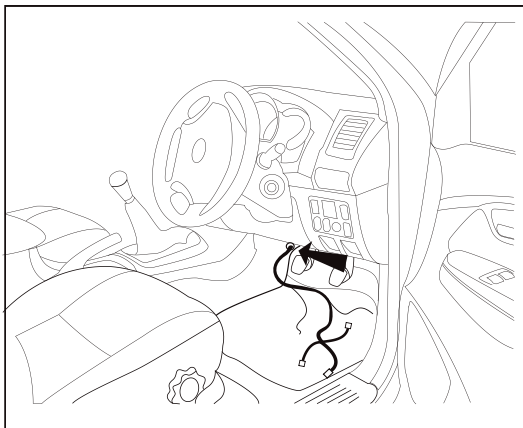
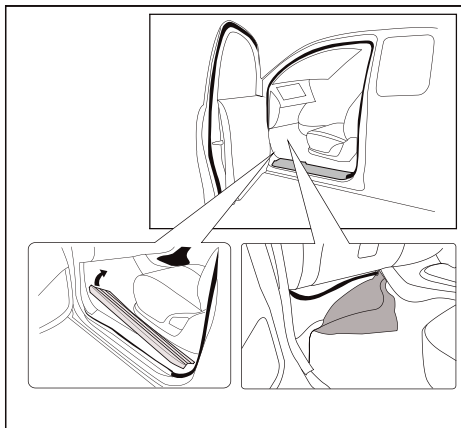
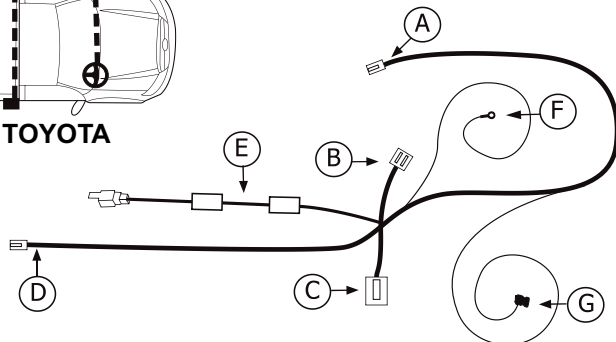

10

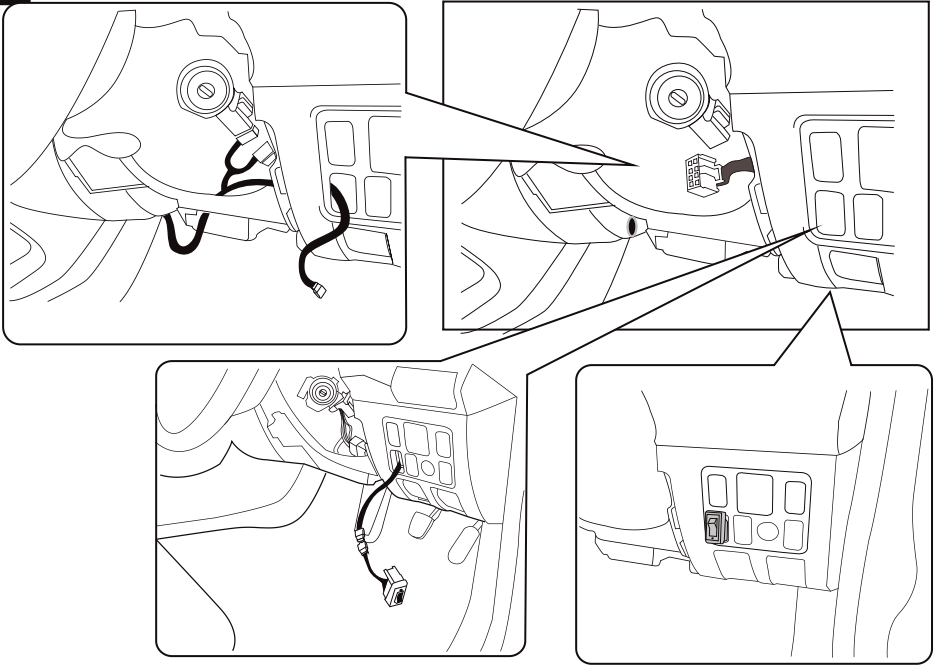

11

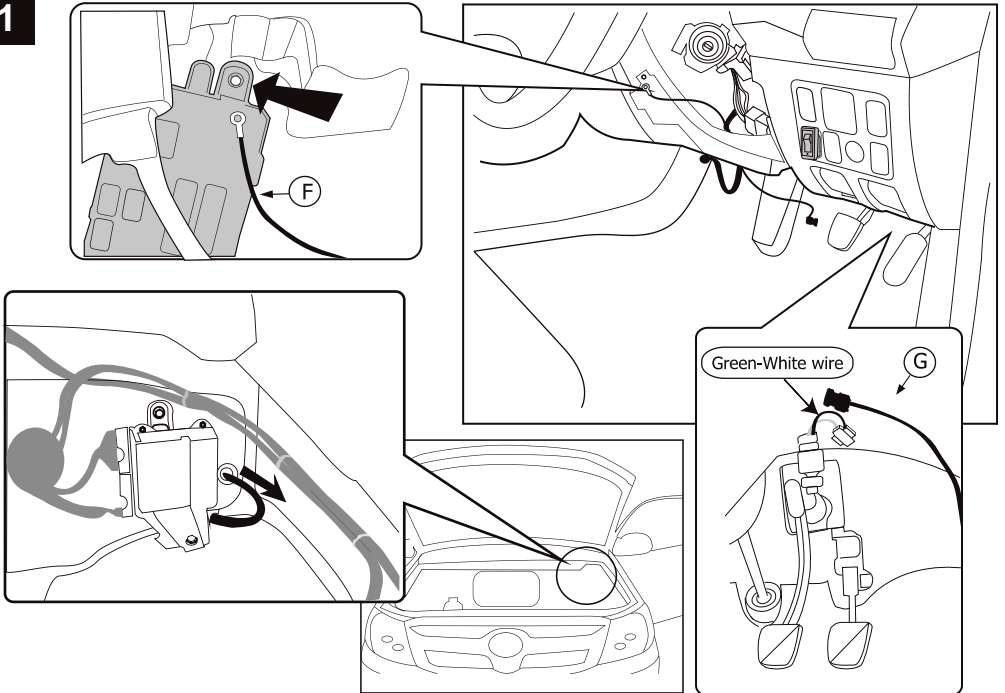



# OPTION # 1

12

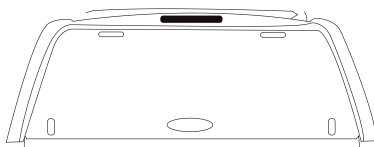
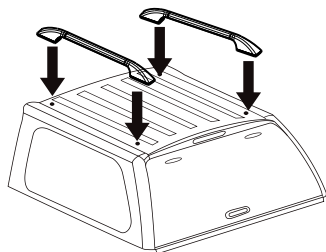

13

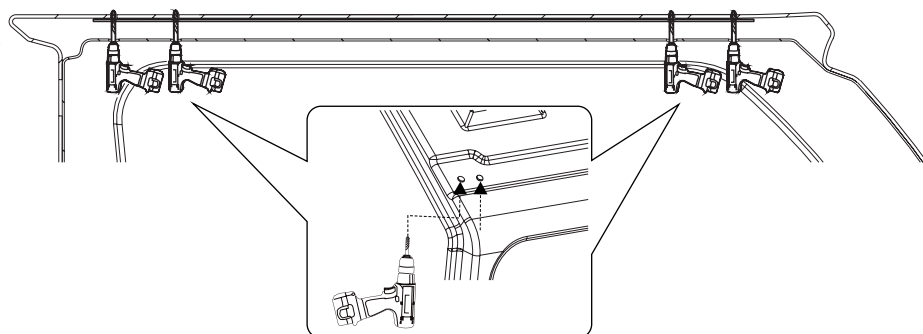
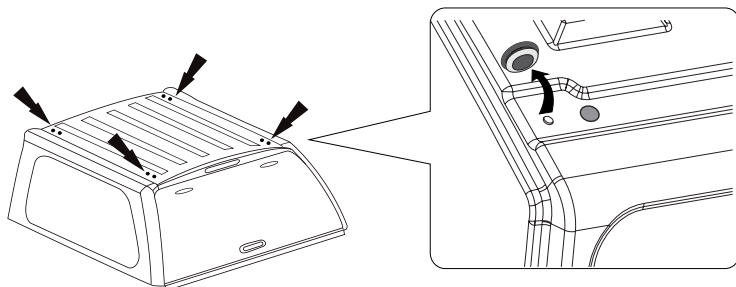

14

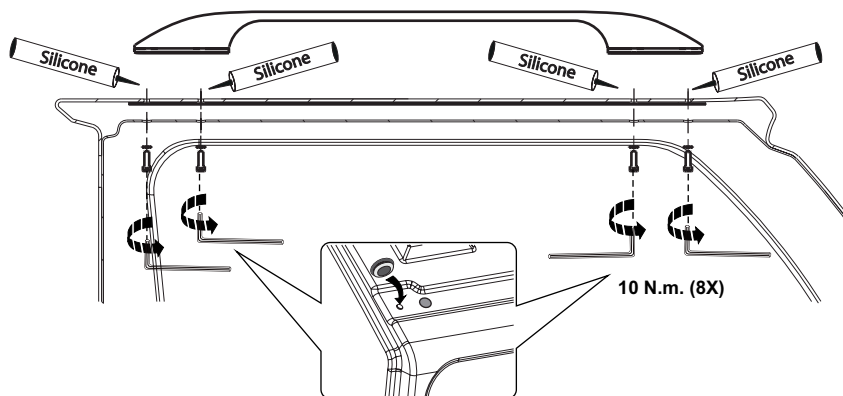

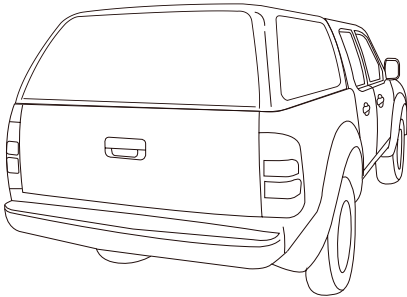
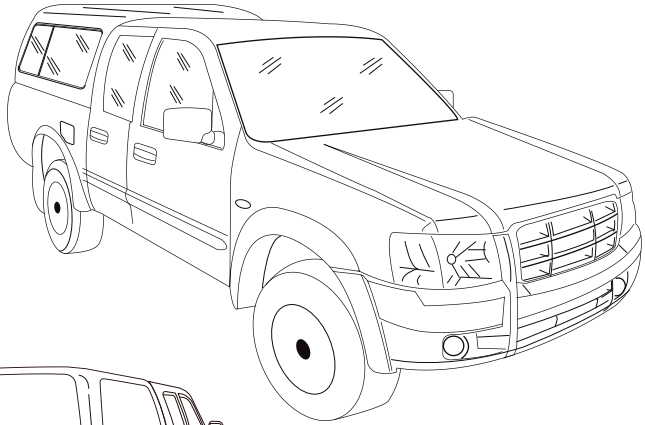
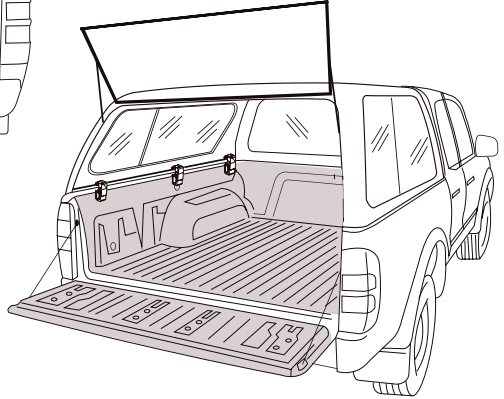
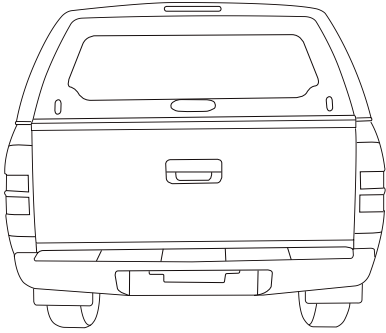





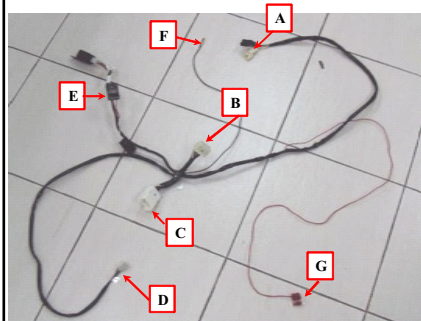
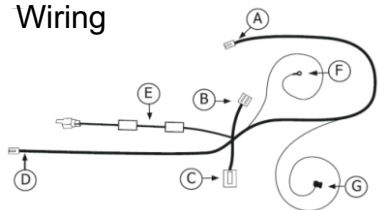





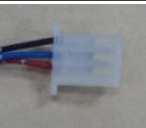

# Wiring diagram for TOYOTA

## Wiring

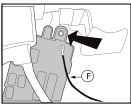
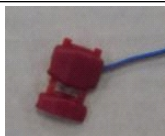

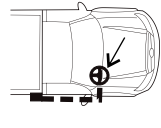
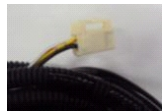
Point	Photo	Function	Reference maual
A		Connect with Canopy's wire	
B		Connect with vehicle's box	
C		Connect with vehicle's box	
D		Connect defroster switch	
E		Fuse	—
F		Ground	
G		Third brake light connect to green wire at Vehicle box	
H		Connect with point A	
I		Connect with Canopy	